

# **Ionic Liquids Today**

**www.iolitec.com**

**Issue 3-11, Wednesday, November 23<sup>rd</sup>, 2011.**

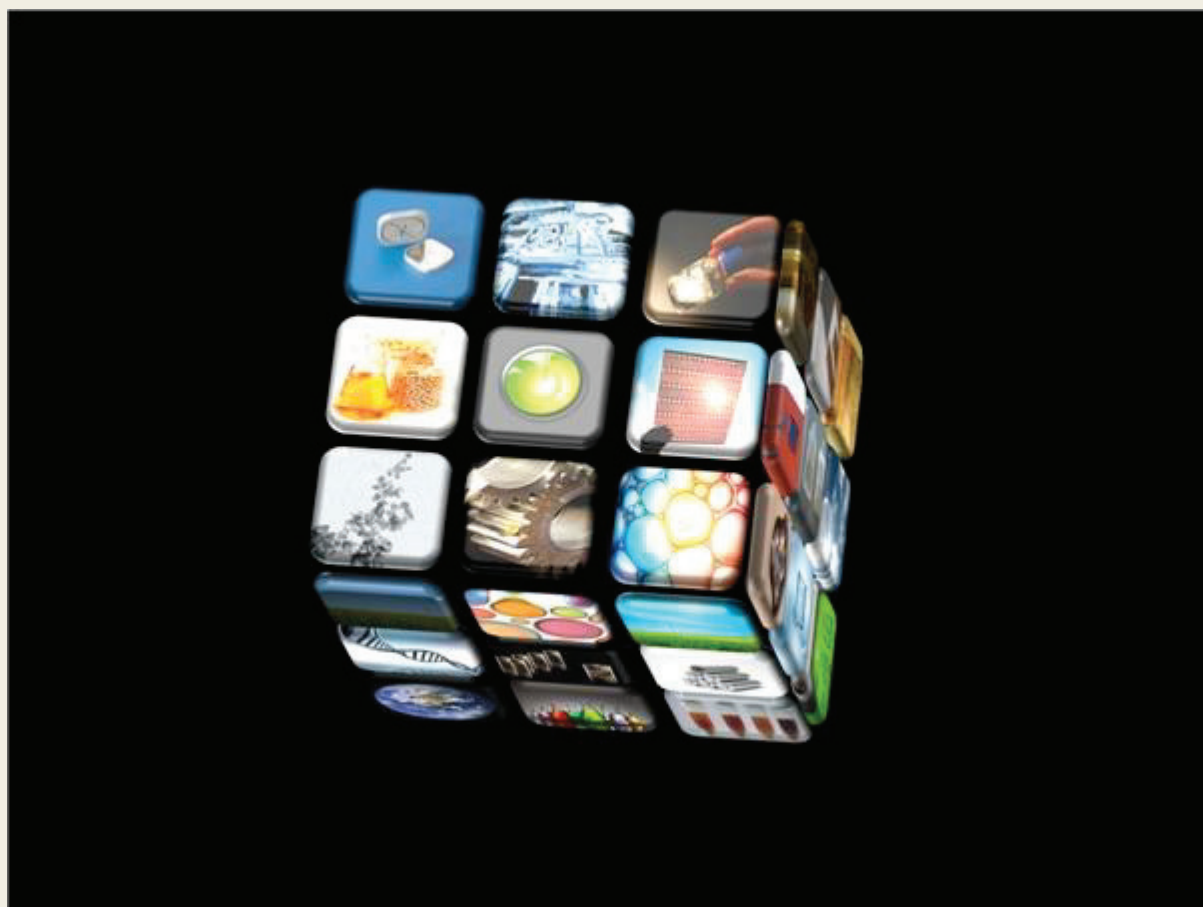

**>>> Ionic Liquids & Polymers**

**>>> Phosphonium-based ionic liquids in liquid-liquid-extraction**

**>>> Viscosities of Tricyanomethanide-based ionic liquids**

© 2011 IOLITEC GmbH, Heilbronn, Germany.

# **Ionic Liquids Today, 03-11**

Wednesday, November 23<sup>rd</sup>, 2011

---

## **Content:**

1	Editorial.....	3
2	Ionic Liquids & Polymers .....	4
3	News from IOLITEC Inc.....	9
4	The use of ionic liquids in liquid-liquid extractions for organic separations	10
5	Physical Properties of Ionic Liquids with Tricyano-methanide Anions .....	15
6	Selected Applications.....	17
7	New Products .....	33
8	Community.....	36

---

### 1 Editorial

With only a few weeks left before Christmas, it is for many people the time to look back what happened all over the year. I'm doing this as well, so I asked myself "What is this year's distillate in terms of ionic liquids research and commercialization? Are there new trends that could be obtained?"

First of all we observed an increasing interest from industry from different branches. Also our sales shifted again a bit more towards industry. I think that this should be not a surprise, because the more than 15'000 publications today about ionic liquids should sooner or later inspire scientists, developers and engineers from companies to design new processes, devices etc. And I can promise you: They already did!

A field that surely got a new momentum this year is the use of ionic liquids as solvents. And this is true for all chemical disciplines (organic, inorganic, macromolecular chemistry etc.). Though anything else but green the "zombies" in the world of ionic liquids, the "classics" or "antichrists" (Seddon) 1-butyl-3-methylimidazolium tetrafluoroborate and hexafluorophosphate, still gain more and more importance. Said to be dead since the mid of the 2ks, they are still heading the lists of publications.

In academic research we identified the need for ultrapure ionic liquids. IOLITEC as a customer oriented company will follow this demand and we'll introduce advanced qualities of some ionic liquids in our 2012 product list.

A novelty in this issue is that we are proud to present an article from another producer of ionic liquids: Jeff Dyck and Al Robertson from Cytec industries demonstrate the use of phosphonium-based ionic liquids in organic separations.

Finally, in the name of IOLITEC I'd like to wish you all the best for 2012, many top-ranked papers, filed & granted patents, increasing sales, or novel products (preferably with IOLITEC's products inside...) and no more crisis scenarios,

Sincerely Yours,

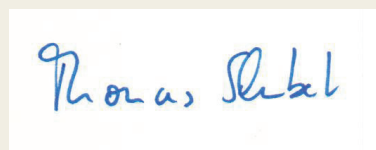

Thomas J. S. Schubert, CEO & Founder, IOLITEC.

## 2 Ionic Liquids & Polymers

By Thomas J. S. Schubert.

Compared to the use of ionic liquids in other applications, their use in polymer related sciences was suggested at the beginning of the 2000s. The situation today is different: A lot of papers suggested and demonstrated successful use of ionic liquids as

- **solvents for polymers and polymerization reactions,**
- **additives for polymers,** and
- **monomers to design novel polymers and copolymers.**

In the following, a brief overview of this fast developing field of science shall be given.

### 2.1 Ionic Liquids as Solvents for Polymers

As mentioned above, the use of ionic liquids as reaction medium in organic synthesis and catalysis was suggested very early. The general interesting combination of properties and the fact that properties can be tailored by design, opened already the door to applications in the field of organic, but also biochemistry and inorganic chemistry. Why should one not use them in polymer chemistry as well?

The start of ionic liquids in polymer research was anything else but a good one: In the mid 1990s Watanabe and coworkers described the insolubility of poly(MMA), poly(St), poly(AN) and poly(EO) in butylpyridinium bromide - AlCl<sub>3</sub>.<sup>1</sup> In 2000 Forsyth *et al.* were able to dissolve poly(*N,N*-dimethyl acrylamide), poly(DMMA), poly(AN) poly(1-vinylpyrrolidinone) and poly(VPyr-coVAc) in Trimethylbutylammonium bis(trifluoromethylsulfonyl)imide (N<sub>1114</sub> BTA).<sup>2</sup> A couple of other solubility studies were made, but a first milestone maybe was the work from Winterton *et al.*, who presented in a comprehensive study the behavior of 17 different polymers over 11

---

<sup>1</sup> M. Watanabe, S. Yamada, K. Sanui and N. Ogata, *Chem. Commun.* **1993**, 929.

<sup>2</sup> M. Forsyth, S. Jiazeng and D. R. MacFarlane, *Electrochim. Acta* **2000**, *45*, 1249.

weeks in the ionic liquids 1-ethyl-3-methylimidazolium tetrafluoroborate (EMIM BF<sub>4</sub>), 1-butyl-3-methylimidazolium hexafluorophosphate (BMIM PF<sub>6</sub>) and 1-methyl-3-octylimidazolium bis(trifluoromethylsulfonyl)imide (OMIM BTA).<sup>3</sup> By far the most polymers were dissolved in OMIM BTA. The rough trend that was identified was that hydrophilic polymers were soluble in all three ionic liquids, while the more hydrophobic polymers were insoluble or only soluble in OMIM BTA. The reason for the enhanced solubility in OMIM BTA may be caused by the different nature of the anion: In general the physical and chemical properties of ionic liquids are dominated more by the anion. As Winterton *et al.* mentioned, BF<sub>4</sub> and PF<sub>6</sub>, which are both non-coordinating anions, showed a more or less similar behavior. The BTA-anion on the other hand is a weakly coordinating anion, leading typically to a behavior which is more similar to hydrophobic molecular solvents.

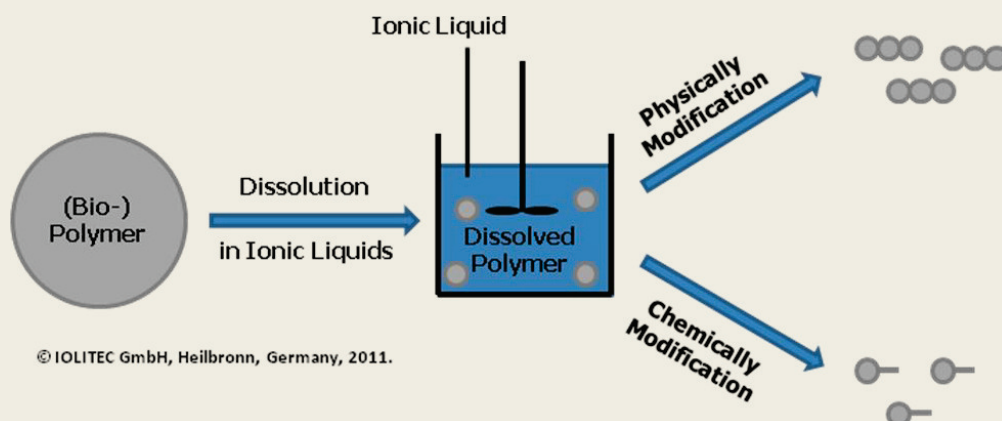

**Fig. 1.** Dissolution of polymers in ionic liquids.

In this context, another important field that should not be neglected is the dissolution of biopolymers: Rogers, one of the important door openers in ionic liquids research, demonstrated in 2002 that the by far most important biopolymer cellulose could be dissolved in some ionic liquids better than in any other solvents.<sup>4</sup> Once this biopolymer is dissolved it can be processed by chemical or physical methods to produce novel chemicals or materials. As a consequence, it is no wonder that the dissolution of cellulose is surely one of the most important fields of ionic liquids

<sup>3</sup> N. Winterton, *J. Mater. Chem.* **2006**, *16*, 4281.

<sup>4</sup> Richard P. Swatloski, Scott K. Spear, John D. Holbrey, and Robin D. Rogers, *J. Am. Chem. Soc.* **2002**, *124*, 4974.

research at the moment, since novel perspectives in the field of biomass-to-liquid transformations are created.

### 2.2 Ionic Liquids as Additives for Polymers

The interesting combinations of physical and chemical properties of many ionic liquids such as their negligible vapor pressure, their conductivity and electrochemical stability, their specific surface tensions, and their specific melting points and/or glass transitions, just to name a few, enable their use as additives for polymers.

For many industrial polymers the addition of plasticizers is of enormous technical relevance. The glass transition temperatures ( $T_g$ ) and the flexibility are the most important properties that are influenced by plasticizers, which are typically caused by polar groups that are not bound covalently to the polymer backbone.

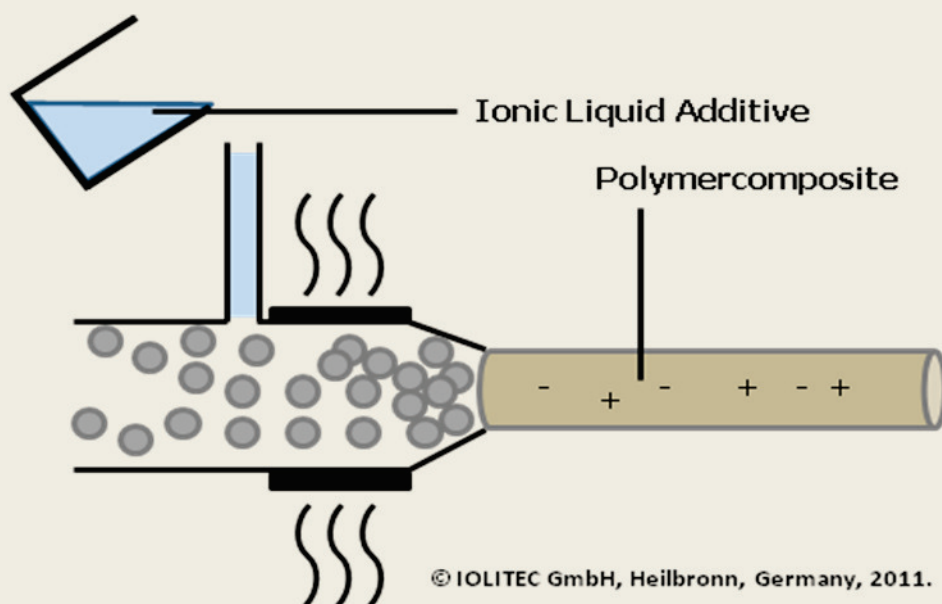

**Fig. 2.** Ionic Liquids as additives for polymers.

As a consequence, it is not a surprise that *polar* ionic liquids may be also interesting materials for the use as plasticizers. Watanabe *et al.*<sup>5</sup> and Scott *et al.*<sup>6</sup> described the

---

<sup>5</sup> M. Watanabe, S. Yamada, K. Sanui, N. Ogata, *Chem. Commun.* **1993**, 929.

interactions of ionic liquids and polymers in terms of the plasticization effect and Scott compared his results to the industrial standard dioctyl phthalate.

In this context it is important to point out that ionic liquids not only show a plasticization effect, they also enhance the electrochemical conductivity of the polymer composite,<sup>7</sup> which reduces the electrostatic charging of the material. Furthermore, if the right ionic liquids are chosen, they also reduce the inflammability of polymers, enabling the application as flame retardant.

This indicates that if the right materials are identified, it is possible to use an ionic liquid as a multipurpose additive. It should also be mentioned, that this field is comparably new and a lot of work still has to be done. As always, economical and ecological questions have to be answered before we'll see first polymers with ionic liquids inside.

Finally, another complete new world in the field of polymer sciences may be created if ionic liquids and nanomaterials are combined: If we just consider the multiple applications and perspectives if just carbon allotropes such as nanotubes, fullerenes or graphene are brought into consideration, it should be worth to waste some thoughts about it – we at IOLITEC are open for it!

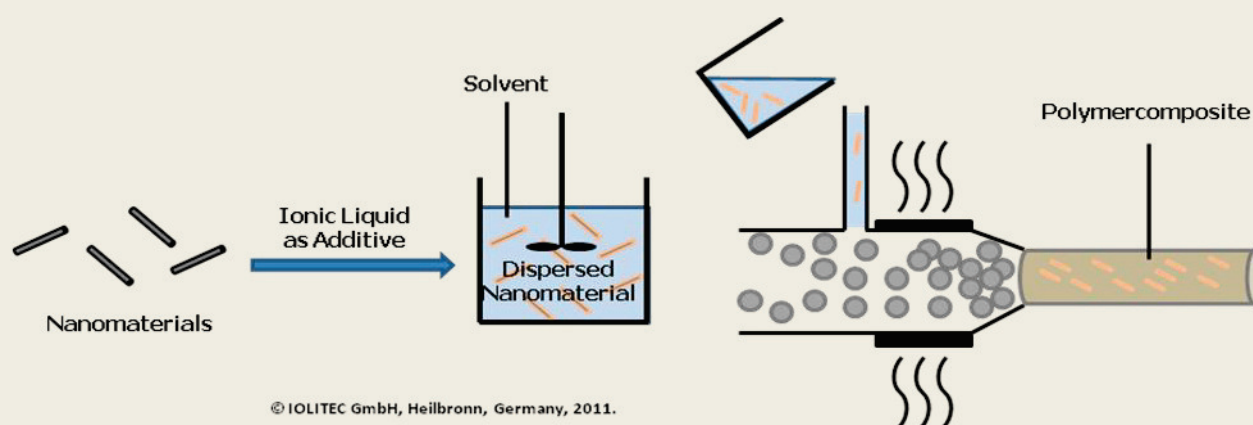

**Fig. 3.** Nanomaterials dispersions as additives for polymers prepared by using ionic liquids.

---

<sup>6</sup> M. P. Scott, M. Rahman, C. S. Brazel, *Eur. Polym. J.* **2003**, *39*, 1947.

<sup>7</sup> Results by IOLITEC GmbH, Germany.

### 2.3 Ionic Liquids-based Polymers and Copolymers

The last part of this article is dedicated to the use of ionic liquid monomers for polymerization. First of all, I personally predict that because of the price of the monomers the derived polymers will surely be no million tons products. But there are important fields of technologies where still no sufficient solution is found.

One striking example is the actual situation in PEM fuel cell technology. The existing polymers are still expensive and their coefficient of performance suffers from the operating temperature, which is limited by the fact that water, which is required for effective proton transport, can be only used up to 80°C.<sup>8</sup> For years fluorinated polymers with sulfonic acid functionalities were the materials of choice.

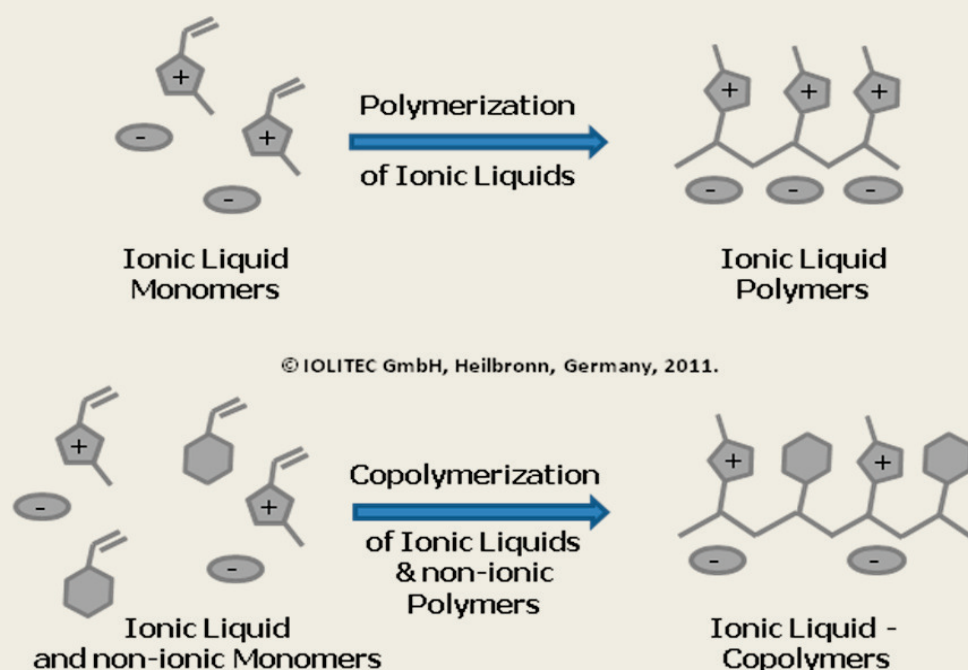

**Fig. 4.** Ionic polymers prepared from ionic liquid monomers and copolymers prepared from ionic liquid monomers and other non-ionic monomers.

The fact that ionic liquids can be designed to have polymerizable functionalities, makes them interesting candidates for the synthesis of electric conductive polymers, or, in view of the application in fuel cells, proton conducting membrane materials.

---

<sup>8</sup> A. V. Anantaraman, C. L. Gardner *J. Electroanal. Chem.* **1996**, 414, 115.



### **3 News from IOLITEC Inc.**

By Tom F. Beyersdorff.

As the end of the year 2011 is approaching I would like to summarize some of IOLITEC's activities during this year.

The first conference IOLITEC attended was the 2011 STLE annual meeting in Atlanta in May 2011. Dr. Beyersdorff gave one of 3 ionic liquid related presentations with the title "Ionic Liquids – Versatile Materials for Lubrication" and presented IOLITEC's research on ionic liquids as dispersing agents for nanomaterials.

In June 2011 IOLITEC attended the 4<sup>th</sup> Conference on Ionic Liquids in Washington D.C. as a proud Gold Sponsor and exhibitor of this successful conference. IOLITEC contributed two presentations to the conference program. Dr. Schubert gave a presentation entitled "Ionic Liquids – Solvents for the size controlled Synthesis and Stabilization of Nanomaterials", followed by Dr. Beyersdorff's presentation on "Novel Electrolytes for Lithium-Ion Batteries".

In the end of August 2011 IOLITEC attended the ACS Fall meeting in Denver as exhibitor on invitation from the Small Business Division within the ACS.

At the same time IOLITEC Inc. kicked-off its Nanomaterials division with the prize money for the 2<sup>nd</sup> place won in the Alabama Launchpad business plan competition. A well selected portfolio nanomaterials is now available from IOLITEC Inc.

At this point IOLITEC would like to thank all our customers for their business in 2011. We hope that we have served all your needs in a timely and accurate manner and hope to continue business with you in the future.

Our 2012 price list for customers in North America will be released in the first quarter of 2012. Once again the number of in stock products has increased and new products are added to the catalog.

Please direct all inquiries to Dr. Tom Beyersdorff:

Email: [Beyersdorff@iolitec.com](mailto:Beyersdorff@iolitec.com)

Phone: 1-205-348-2831

[www.iolitec-usa.com](http://www.iolitec-usa.com)

### **4 The use of ionic liquids in liquid-liquid extractions for organic separations**

By Jeffrey Dyck & Al Robertson (Cytec Industries Inc.)

#### **4.1 Introduction**

It is well-known and generally accepted that energy derived from fossil fuels will be insufficient to sustain world-wide demand indefinitely.<sup>1</sup> Additionally, combustion of such fuels emits CO<sub>2</sub> and many other pollutants linked to climate change. Therefore, development of alternative, sustainable energy sources has grown exponentially in recent years and shows no signs of slowing. One example is the introduction of biofuels (i.e. bio-diesel, bio-ethanol, bio-butanol, etc.) to supplement and/or replace petroleum based transportation fuels.<sup>2</sup>

Bio-alcohols are produced from the fermentation of biomass; typically corn, wheat, sugarcane, etc. Significant efforts are also being made to utilize lignocellulosic crops (i.e. grasses) and agricultural by-products such as corn stalks to reduce dependence on food crops as sources of biomass. In all cases, concentration of bio-alcohol in the fermentation broth is quite low and separation of alcohols from the aqueous medium is not trivial. Separation is typically achieved using high energy processes such as distillation. Energy consumed during the separation reduces the overall energetic content of the production process, particularly for more dilute fermentation broths, thereby inhibiting efficiency and cost competitiveness versus petroleum based products.

Liquid-liquid extraction (LLE) has been proposed as an alternative separation method that has the potential to reduce the energy consumption up to 40% when compared with distillation techniques.<sup>3</sup> Extraction of dilute fermentation broths with ionic liquids is a current area of interest and has shown to be a promising route for efficient separation of alcohols.<sup>3-8</sup>

## 4.2 Phosphonium Ionic Liquids for Bio-Alcohol Extraction:

Coutinho *et. al.* explored the use of phosphonium ionic liquids (Figure 1) to separate ethanol-water mixtures by LLE using ternary phase diagrams and compared the results with similar studies using imidazolium cations.<sup>5</sup> CYPHOS<sup>®</sup> ionic liquids are manufactured on a commercial scale by Cytec Industries Inc. and samples are available through a distribution agreement with IoLiTec.

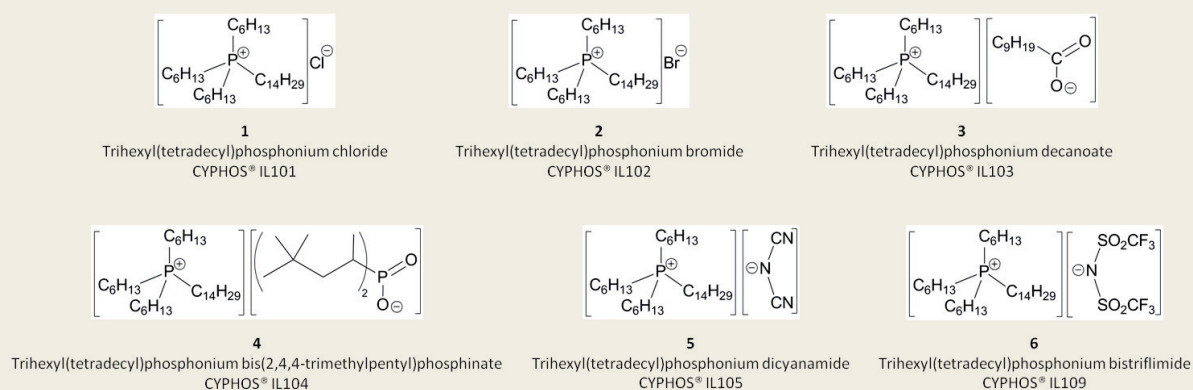

**Figure 1:** Phosphonium ionic liquids studied for extraction of ethanol using LLE by *Coutinho et. al.*

Both selectivity and relative capacity of the IL for ethanol were determined as well as the maximum ethanol extraction on a mass ratio basis. Ethanol concentrations from extraction with CYPHOS<sup>®</sup> IL109 (**6**) were estimated at 87 wt% compared to ~65 wt% using 1-hexyl-3-methylimidazolium bistriflimide.<sup>5</sup> Estimated extraction with CYPHOS<sup>®</sup> IL105 (**5**) was only slightly lower at 82 wt% based on the ternary diagrams. However, the dicyanamide anion also exhibited a significantly higher selectivity for ethanol.

*Coutinho et. al.* propose that LLE is most effective in the low concentration regime and envision a process whereby the fermentation stream is concentrated using ionic liquid mediated LLE followed by pervaporation to generate anhydrous ethanol.

For this purpose, phosphonium ionic liquids are favored since they are typically less dense than water and can therefore be used in traditional aqueous decantation systems where the solvents they are displacing are also less dense than water.

Besides bio-ethanol, bio-butanol is gaining popularity as a more advantageous alternative to petroleum based transportation fuel.<sup>9</sup> *Chung et. al.* evaluated several phosphonium and ammonium ionic liquids to determine the relative effects of cation and anion moieties. They report that while ILs with bistriflamide anions are most often cited, dicyanamide anions have partition coefficients that are seven times as high for butanol extraction. Still greater efficient separation is predicted for dialkyl sulfosuccinate anions. Phosphonium and ammonium cations were specifically chosen for this study as they have been shown to exhibit higher thermal and chemical stability, greater hydrophobicity and a larger extraction capacity than their imidazolium and pyrrolidinium analogues.<sup>10</sup>

A common theme throughout LLE studies is the importance of accurately predicting partition coefficients for new molecules based on existing experimental data and various solvation models. The current predictive powers of these models (*i.e.* COSMO-RS, NRTL, etc.) are limited<sup>4</sup> but are certain to improve as more data becomes available from more extensive studies.

### 4.3 Biocompatibility of Ionic Liquids:

In addition to elevated alcohol partitioning, the IL must also be biocompatible with the fermentation microorganisms. Some data related to EC<sub>50</sub> values for enzymatic activity is available<sup>11</sup> but the conditions do not reflect the actual fermentation environment for bio-alcohols, which typically use solventogenic *Clostridia* bacterial strains. These bacteria secrete numerous enzymes that facilitate the breakdown of polymeric carbohydrates into monomers. Phosphonium ionic liquids have been found to have generally lower inhibitory activity to enzymes when compared to imidazolium ILs<sup>2,3</sup> and other organic extractants.<sup>12</sup> CYPHOS® IL109 (**6**) was found to be completely biocompatible with certain strains of *Clostridia* bacteria while the more selective CYPHOS® IL105 (**5**) showed limited to moderate biocompatibility.<sup>6</sup>

It should be noted that biocompatibility is not necessarily equivalent to toxicity, as increasingly hydrophobic ionic liquids will have less interaction with the aqueous medium and therefore with the microorganisms in the aqueous phase.

Incorporating ionic liquids into membranes (Supported Ionic Liquid Membranes; SILMs) is another strategy that can be applied to LLE<sup>13,14</sup> in which case biocompatibility is less of a concern as there is limited microbial exposure to the IL. Finally, genetic engineering has made possible the development of more resistant bacterial strains that are able to convert a broader variety of biomass sources.<sup>15</sup>

#### 4.4 Conclusions:

Besides extraction of bio-alcohols, ionic liquids have also found application in the separation of other organic mixtures such as aliphatics from aromatics and alkanes from alkenes.<sup>16-18</sup> The selection process for ionic liquid candidates is often complex and is limited by the shortcomings of existing predictive models. It is important to take a holistic view of ionic liquid properties and process conditions to ensure suitability of other relevant factors such as recyclability, stability and cost. Ultimately, the final process needs to be economically viable to compete with and/or displace existing and alternative technologies.

#### References:

1. <http://www.ipcc.ch/>
2. E. Gnansounou, A. Dauriate, *Bioresour. Technol.* **2010**, 101, 4980.
3. T. Boudreau, G. Hill, *Process Biochem.* **2006**, 41, 980.
4. C. Neves, J. Granjo, M. Freire, A. Robertson, N. Oliviear, J. Coutinho\*, *Green Chem.* **2011**, 13, 1517.
5. A. Chapeaux, L. Simoni, T. Ronan, M. Stadherr, J. Brennecke\*, *Green Chem.* **2008**, 10, 1301.
6. H. Cascon, S. Choudhari, G. Nisola, E. Vivas, D. Lee, W. Chung\*, *Sep. Purif. Technol.* **2011**, 78, 164.
7. S. Ha, N. Mai, Y. Koo, *Process Biochem.* **2010**, 45, 1899.
8. M. Seiler\*, C. Jork, A. Kavarnou, W. Arlt\*, R. Hirsch, *AIChE J.* **2004**, 50, 2439.
9. [http://www2.dupont.com/Sustainability/en\\_US/Marketplace/Transportation/biofuels.html](http://www2.dupont.com/Sustainability/en_US/Marketplace/Transportation/biofuels.html)
10. R. Condemarin, P. Scovazzo\*, *J. Membr. Sci.* **2009**, 147, 51.
11. <http://www.il-eco.uft.uni-bremen.de/>
12. J. Gorke, F. Sreinc, R. Kazlauskas, *Biotech. & Bioproc. Eng.* **2010**, 15, 40.
13. M. Matsumoto\*, A. Panigrahi, Y. Murakami, K. Kondo, *Membranes*, **2011**, 1, 98.
14. J. Martak, S. Schlosser\*, S. Vlckova, *J. Membr. Sci.* **2008**, 318, 298.
15. C. Machado, *V Latin-American and the Caribbean Biofuels Seminar*, **2010**.
16. A. Marciniak, *Fluid Phase Equilibr.* **2010**, 294, 213.
17. M. Jongmans\*, B. Schuur, A. Haan, *Ind. Eng. Chem. Res.* **2011**, 50, 10800.
18. U. Domanska, K. Padaszynski, *J. Phys. Chem. B*, **2008**, 112, 11054.

## Ionic Liquids Today, 03-11

Wednesday, November 23<sup>rd</sup>, 2011

---

**Trademark Notice:** The ® indicates a Registered Trademark in the United States and the ™ or \* indicates a Trademark in the United States. The mark may also be registered, the subject of an application for registration or a trademark in other countries.

**Disclaimer:** Cytec Industries Inc. in its own name and on behalf of its affiliated companies (collectively, "Cytec") decline any liability with respect to the use made by anyone of the information contained herein. The information contained herein represents Cytec's best knowledge thereon without constituting any express or implied guarantee or warranty of any kind (including, but not limited to, regarding the accuracy, the completeness or relevance of the data set out herein). Nothing contained herein shall be construed as conferring any license or right under any patent or other intellectual property rights of Cytec or of any third party. The information relating to the products is given for information purposes only. No guarantee or warranty is provided that the product and/or information is adapted for any specific use, performance or result and that product and/or information do not infringe any Cytec and/or third party intellectual property rights. The user should perform its own tests to determine the suitability for a particular purpose. The final choice of use of a product and/or information as well as the investigation of any possible violation of intellectual property rights of Cytec and/or third parties remains the sole responsibility of the user.

©2011 Cytec Industries Inc. All Rights Reserved.

## 5 Physical Properties of Ionic Liquids with Tricyanomethanide Anions

By Maria Taige.

Ionic liquids with tricyanomethanide anions were introduced in our last newsletter on the example of 1-ethyl-3-methylimidazolium tricyanomethanide (EMIM TCM) as ionic liquids with low viscosities and high conductivities. Today we would like to present physical properties of 1-butyl-3-methylimidazolium tricyanomethanide (BMIM TCM), 1-butyl-1-methylpyrrolidinium tricyanomethanide (BMPyrr TCM) and of 1-butyl-4-methylpyridinium tricyanomethanide (Bu4Pic TCM). The viscosities of these ionic liquids are significantly higher as the viscosity of 1-ethyl-3-methylimidazolium tricyanomethanide (EMIM TCM) (Figure 1). Bu4Pic TCM has with a viscosity of 32.5 cP at room temperature which is the highest viscosity among the selected ionic liquids. BMIM TCM has the lowest viscosity of the three selected ionic liquids but even this IL has a viscosity of 25.7 cP at 25 °C which is more than 10 cP higher than that of EMIM TCM. Despite this, the viscosities of BMIM TCM, BMPyrr TCM and Bu4Pic TCM are among the lowest viscosities of all ionic liquids.

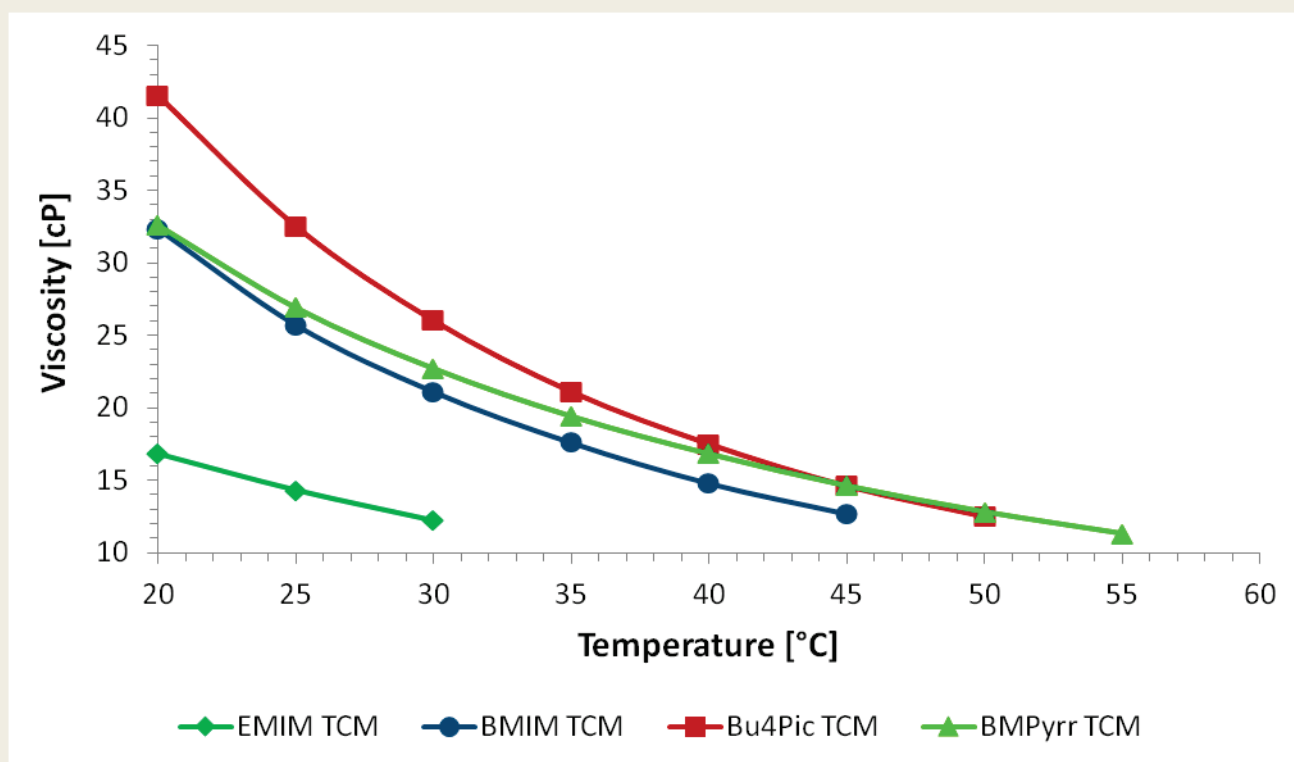
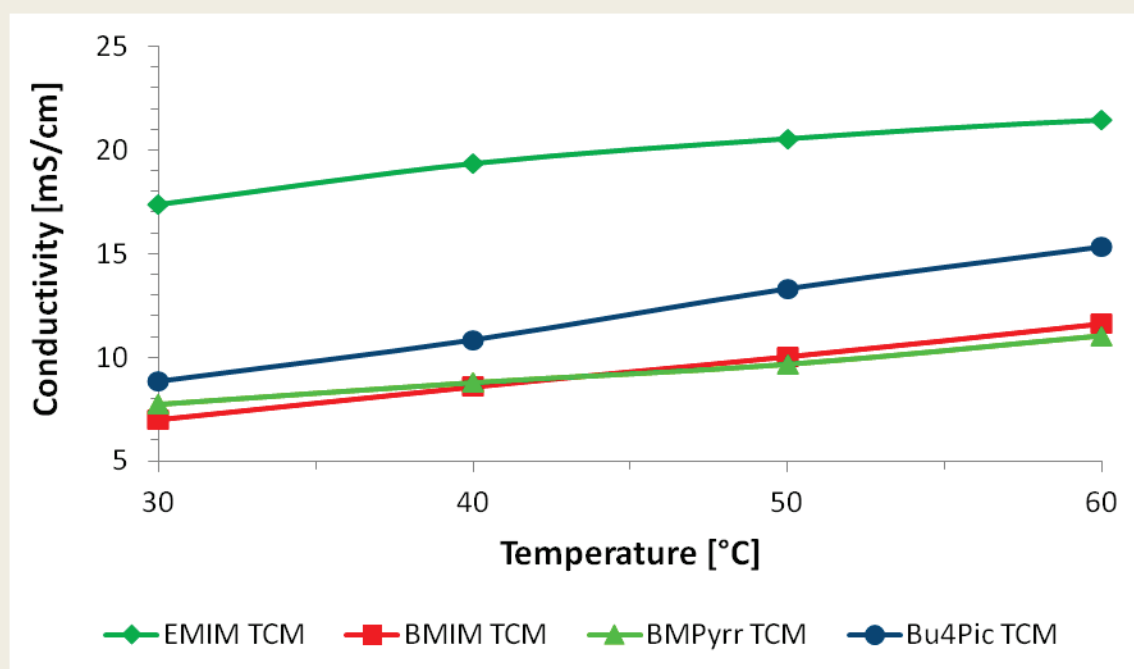

**Figure 1:** Temperature-dependent viscosities of selected ionic liquids with tricyanomethanide anions.

## Ionic Liquids Today, 03-11

Wednesday, November 23<sup>rd</sup>, 2011

Since the conductivities of the ILs depend on their viscosities, BMIM TCM, BMPyrr TCM and Bu4Pic TCM have lower conductivities than EMIM TCM (Figure 2). BMIM TCM has a conductivity of 8.8 mS/cm at 30 °C, while EMIM TCM has a conductivity of 17.3 mS/cm at this temperature. The conductivities of Bu4Pic TCM (7.0 mS/cm) and BMPyrr TCM (7.7 mS/cm) are respectively comparable and even a little bit lower than that of BMIM TCM. Nevertheless, the conductivities of Bu4Pic TCM, BMIM TCM and BMPyrr TCM are in the same range as the conductivities of BMIM DCA and BMPyrr DCA, which are among the ionic liquids with very high conductivity. The major advantages of ILs with TCM anions in comparison to ILs with DCA anions are their higher stabilities.



**Figure 2:** Temperature-dependent conductivity of selected ionic liquids with tricyanomethanide anions.



### 6 Selected Applications

By Boyan Iliev (BI), Hülya Sahin (HS), Maria Taige (MT), Sven Sauer (SS), Marcin Smiglak (MS), Frank Stiemke (FS), Tom F. Beyersdorff (TB) and Thomas J. S. Schubert (TS).

#### **Development of safe, green and high performance ionic liquids-based batteries (ILLIBATT project) (MT)**

A. Balducci, S.S. Jeong, G.T. Kim, S. Passerini, M. Winter, M. Schmuck, G.B. Appetecchi, R. Marcilla, D. Mecerreyes, V. Barsukov, V. Khomenko, I. Cantero, I. De Meazza, M. Holzapfel, N. Tran *J. Power Sources*. **2011**, *196*, 9719-9730.

Lithium metal batteries as well as lithium ion batteries are important energy storage systems, which are not only used as energy sources for mobile phones and laptops but also as energy sources for applications with high power demand like automobiles. Considering the safety and the temperature stability of commercial available lithium and lithium ion batteries there are still some improvements needed to make those batteries to the favored energy storage systems. Due to their high electrochemical stability, their negligible vapor pressure, their non-flammability and their wide liquid range ionic liquids seem to be the substances of choice in order to design safer lithium and lithium ion batteries with an enhanced operative temperature range. However, further improvements of the lithium ion conductivity are necessary in order to make ionic liquids to suitable electrolytes for commercially available lithium and lithium ion batteries.

Balducci et al. recently showed that the design of high performance ionic liquid based lithium metal and lithium ion batteries is possible. Scanning different cell geometries, they found that the combination of a composite lithium titanate (LTO) anode together with an electrolyte mixture of 1-butyl-1-methylpyrrolidinium bis(fluorosulfonyl)imide (BMPyrr FSI) and Lithium bis(trifluoromethylsulfonyl)imide (Li BTA) and a composite lithium iron phosphate (LFP) cathode showed the best performance of all tested cell chemistries for a lithium ion battery. The performance of this lithium ion battery cell is comparable to that of a battery cell with a conventional electrolyte. A battery cell containing a lithium metal anode, a composite lithium iron phosphate cathode and a polymer electrolyte based on cross linked poly(ethylenoxide), 1-butyl-1-methylpyrrolidinium bis(trifluoromethylsulfonyl)imide and lithium bis(trifluoromethylsulfonyl)imide is introduced as high performance

## Ionic Liquids Today, 03-11

Wednesday, November 23<sup>rd</sup>, 2011

lithium metal polymer battery, which do not suffer from the large safety risk of lithium metal batteries with conventional organic electrolytes. The authors could show that the battery cells containing the above mentioned ionic liquid based electrolytes are safer than conventional battery cells. In contrary to cells with conventional electrolytes, no swelling was observed during tests under vacuum and the battery showed no significant weight loss or drop in the performance after thermal cycling. The temperature increased only slightly during overcharge tests and the nail penetration test did not lead to a full short-circuit.

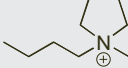
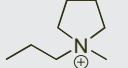
1-Butyl-1-methylpyrrolidinium bis(trifluoromethylsulfonyl)imide, 99% <b>Reduced</b>				1-Methyl-1-propylpyrrolidinium bis(trifluoromethylsulfonyl)imide, 99% <b>Reduced</b>			
IL-0035-HP	[223437-11-4]	C <sub>11</sub> H <sub>20</sub> F <sub>6</sub> N <sub>2</sub> O <sub>4</sub> S <sub>2</sub>	MW 422.41	IL-0044-HP	[223437-05-6]	C <sub>10</sub> H <sub>18</sub> F <sub>6</sub> N <sub>2</sub> O <sub>4</sub> S <sub>2</sub>	MW 408.38
							
		(CF <sub>3</sub> SO <sub>2</sub> ) <sub>2</sub> N <sup>⊖</sup>				(CF <sub>3</sub> SO <sub>2</sub> ) <sub>2</sub> N <sup>⊖</sup>	
		25 g	52.00 €			25 g	52.00 €
		50 g	69.00 €			50 g	69.00 €
		100 g	115.00 €			100 g	115.00 €
		250 g	235.00 €			250 g	235.00 €
500 g	385.00 €	500 g	385.00 €				
1 kg	695.00 €	1 kg	695.00 €				
5 kg	2'780.00 €	5 kg	2'780.00 €				

We also offer 1-Butyl-1-methylpyrrolidinium bis(fluorosulfonyl)imide (BMPyrr FSI) as custom synthesis. Please ask us, if you are interested in our specifications or prices.

### Direct bioethanol production from cellulose by the combination of cellulase-displaying yeast and ionic liquid pretreatment (MS)

K. Nakashima, K. Yamaguchi, N. Taniguchi, S. Arai, R. Yamada, S. Katahira, N. Ishida, H. Takahashi, C. Ogino, A. Kondob *Green Chem.*, **2011**, *13*, 2948.

Currently one of the most interesting areas of research regarding utilization of Ionic Liquids is pre-treatment and reprocessing of biomass, including bioethanol production from cellulose pre-treated with ionic liquids. Such processes described in the literature often require pre-treatment of cellulose with ionic liquids, enzymatic hydrolysis of cellulose to sugars (mainly by cellulase), and in the last step fermentation of cellulose to bioethanol by microorganisms like yeast or bacteria.

## Ionic Liquids Today, 03-11

Wednesday, November 23<sup>rd</sup>, 2011

In the recent publication from Ogino *et al.*, authors describe a successful bioethanol production process that was performed entirely in a single vessel from the dissolution of cellulose to ethanol production. For their research the authors developed functional yeast ("arming yeast") that display a cellulase enzyme on its cell surface, thus allowing for the hydrolysis of pre-treated cellulose directly before the fermentation process.

For this research three ionic liquids were used namely: 1-ethyl-3-methylimidazolium diethyl phosphate (IL-0052), 1-ethyl-3-methylimidazolium acetate (IL-0189), and 1-ethyl-3-methylimidazolium chloride (IL-0093). Even though, the fermentation process was performed directly after the solution of pre-treated cellulose in ionic liquid was mixed with counter solvents to reconstitute cellulose, the yeast could ferment and produce ethanol under such conditions. It was found that the critical concentration of ionic liquids for yeast fermentation was around 200 mM. Moreover, after completion of the fermentation process, the soluble fractions containing ionic liquid and produced ethanol were separated by ethanol distillation and the ionic liquid was reused after drying in the next process of cellulose pre-treatment. In case of 1-ethyl-3-methylimidazolium diethyl phosphate, the ionic liquid recovery rate was reaching 82%.

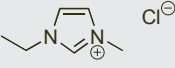
1-Ethyl-3-methylimidazolium chloride, >98%			Reduced	
IL-0093-HP	[65039-09-0]	C <sub>6</sub> H <sub>11</sub> ClN <sub>2</sub>	MW 146.62	
		25 g	64.00 €	
		50 g	85.00 €	
		100 g	113.00 €	
		250 g	240.00 €	
		500 g	405.00 €	
		1 kg	695.00 €	
		5 kg	2'780.00 €	
<b>Filled in as crystalline solid!</b>				

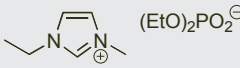
1-Ethyl-3-methylimidazolium diethyl phosphate, >98%			Reduced	
IL-0052-HP	[663199-29-9]	C <sub>10</sub> H <sub>21</sub> N <sub>2</sub> O <sub>4</sub> P	MW 264.26	
		25 g	65.00 €	
		50 g	87.00 €	
		100 g	116.00 €	
		250 g	232.00 €	
		500 g	375.00 €	
		1 kg	595.00 €	
		5 kg	2'380.00 €	

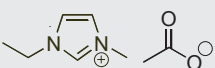

1-Ethyl-3-methylimidazolium acetate, >95%				
IL-0189-TG	[143314-17-4]	C <sub>8</sub> H <sub>14</sub> N <sub>2</sub> O <sub>2</sub>	MW 170.21	
		25 g	60.00 €	
		50 g	75.00 €	
		100 g	115.00 €	
		250 g	175.00 €	
		500 g	265.00 €	
		1 kg	395.00 €	
		5 kg	1'580.00 €	

### C–S cross-coupling of thiols with aryl iodides under ligand-free conditions using nano copper oxide as a recyclable catalyst in ionic liquid (HS)

R. S. Schwab, D. Singh, E. E. Alberto, P. Piquini, O. E. D. Rodrigues, A. L. Braga, *Catal. Sci. Technol.*, **2011**, *1*, 569–573.

Aryl sulfides are important intermediates in organic synthesis and transformations. In addition, there are numerous aryl sulfide derivatives which are known to be biological and pharmaceutically active. Manifold conditions have been investigated in order to elude the limitations during the S-arylation process, as the S-S coupling and the deactivation of the catalyst.

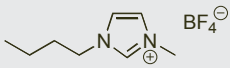
*Braga et al.* demonstrated another example in which nanotechnology and ionic liquids were combined: Using CuO nanopowder they studied different ionic liquids, from which 1-butyl-3-methylimidazolium tetrafluoroborate led to the best results. This combination enabled the use of easily accessible alkylating agents, low amount of catalyst and good yields in short time. Furthermore, the developed conditions are described as economic and eco-friendly, since the ionic liquid and the catalyst can easily be recovered and reused.

1-Butyl-3-methylimidazolium tetrafluoroborate, 99%			
			Reduced
IL-0012-HP	[174501-65-6]	C <sub>8</sub> H <sub>15</sub> BF <sub>4</sub> N <sub>2</sub>	MW 226.02
		25 g	27.00 €
		50 g	36.00 €
		100 g	55.00 €
		250 g	122.00 €
		500 g	219.00 €
		1 kg	395.00 €
	5 kg	1'580.00 €	
Copper(II)oxide powder, 99.9%			
NO-0031-HP	[1317-38-0]	CuO	MW 79.55
APS: 40-80 nm		25 g	
SSA: -		100 g	
PM: -		500 g	
Appearance: black powder		1 kg	
		Warning	
		H 302, 412	
		P 273, 501	
Packaging: Powder in PE bottle			

### Transparent ionic liquid-phenol resin hybrids with high ionic conductivity (HS)

T. Ogoshi, T. Onodera, T. Yamagishi, Y. Nakamoto, A. Kagata, N. Matsumi, K. Aoi, *Polymer Journal*, **2011**, *43*, 421–424.

Solid-state organic polymer electrolytes have attracted remarkable attention because of their potential application in various electrical devices, particularly lithium-ion batteries, fuel cells and double-layer capacitors. Due to their properties like high ionic conductivity, thermal stability and low volatility, there is an increasing interest for polymer electrolytes hybridized with ionic liquids. An additional advantage is their good solubility for organic and inorganic compounds.

*Ogoshi et al.* prepared transparent conductive ionic liquid-phenol resin hybrids with 1-ethyl-3-methylimidazolium bis(trifluoromethanesulfonyl)imide as the ionic liquid. By using the *in situ* method -polymerization and simultaneous crosslinking of phenol in the ionic liquid- they could obtain homogenous and transparent hybrid materials. The researchers are now studying the mechanical and thermal stabilities of the hybrids. We are curious to see, what they will present us.

#### 1-Ethyl-3-methylimidazolium bis(trifluoromethylsulfonyl)imide, 99%

IL-0023-HP [174899-82-2] C<sub>8</sub>H<sub>11</sub>F<sub>6</sub>N<sub>3</sub>O<sub>4</sub>S<sub>2</sub> MW 391.31

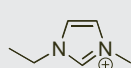

25 g	55.00 €
50 g	75.00 €
100 g	120.00 €
250 g	260.00 €
500 g	440.00 €
1 kg	745.00 €
5 kg	2'980.00 €

### Ethylammonium Nitrate (EAN)/Tf<sub>2</sub>O and EAN/TFAA: Ionic Liquid Based Systems for Aromatic Nitration (SS)

G. Aridoss, K. K. Laali *J. Org. Chem.* **2011**, *76*, 8088.

Ionic liquids are high potential solvents and reaction media. Another amazing example for their application is described in the recently published article of Kenneth K. Laali in JOCs. He describes the use of ethylammonium nitrate (EAN) in combination with triflic anhydride / TFAA respectively as reaction system for the nitration of a wide variety of aromatic and hetero aromatic compounds. EAN is used as solvent and forms reactive intermediates with triflic anhydride and TFAA like triflyl nitrate and trifluoroacetyl nitrate respectively which act as electrophiles. Especially with the system EAN/Tf<sub>2</sub>O it is easily possible to perform nitration of even strongly deactivated aromatic systems under very mild conditions. As drawback they state that both systems exhibit a substrate selectivity in between values reported for covalent nitrates and preformed nitronium salts. The ionic liquid could be recovered and reused by simple methods.

The mild reaction conditions, the readily available reagents together with a simple workup procedure, and reuse as well as recycling of the ionic liquid make this an excellent nitration method with good potential for wide application in aromatic chemistry.

Ethylammonium nitrate, >97%		Reduced	
IL-0043-SG	[22113-86-6]	C <sub>2</sub> H <sub>9</sub> N <sub>2</sub> O <sub>3</sub>	MW 108.11
		25 g	39.00 €
		50 g	55.00 €
		100 g	89.00 €
		250 g	189.00 €
		500 g	320.00 €
		1 kg	545.00 €
		5 kg	2'180.00 €

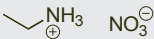

### Recent advances in ionic liquid catalysis (BI)

Q. Zhang, S. Zhang, Y. Deng *Green Chem.*, **2011**, *13*, 2619.

Due to their unique properties, ionic liquids have offered great potential for developing clean catalytic technologies. The authors give a brief account of the recent advances in ionic liquid catalysis, with emphasis on four hot fields, *viz.* biomass, conversion in ionic liquids, catalytic production of fine chemicals in ionic liquids, supported ionic liquid phase catalysis, as well as Friedel–Crafts reactions in ionic liquids. According to recent publications, the most successful ILs for cellulose depolymerisation are BMIM Cl, EMIM Cl and EMIM OAc, while for HMF production EMIM BF<sub>4</sub> and BMIM BF<sub>4</sub> can be also used.

It is encouraging to see, that more and more pharmaceutical intermediates and pesticide precursors are being produced in ILs. In this field, the classics like BMIM BF<sub>4</sub> and BMIM PF<sub>6</sub> seem to dominate the literature.

Although ILs show high catalytic activity and good selectivity, their widespread use in catalytic processes is still hampered by several practical drawbacks, such as product isolation, high cost and catalyst recovery. In order to overcome these disadvantages, the Supported IL Phase Catalysis (SILPC) method was developed. Many examples show, that the incorporation of ILs on a solid matrix is not that difficult and delivers very good results.

The Friedel-Crafts alkylation catalysis is still dominated by mainly imidazolium or ammonium aluminates, but some good results for alkylation of benzene have also been achieved with BMIM PF<sub>6</sub> and EMIM SbF<sub>6</sub>.

In conclusion, the main advantages of IL catalysts are the high activity and selectivity, combined with very good thermal stability, but the points still needing attention are the relatively high prices and high viscosities of ionic liquids.

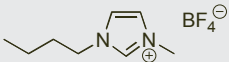
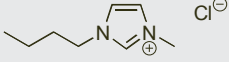
1-Butyl-3-methylimidazolium tetrafluoroborate, 99%				Reduced		1-Butyl-3-methylimidazolium chloride, 99%				Reduced	
IL-0012-HP	[174501-65-6]	C <sub>8</sub> H <sub>15</sub> BF <sub>4</sub> N <sub>2</sub>	MW 226.02			IL-0014-HP	[79917-90-1]	C <sub>8</sub> H <sub>15</sub> ClN <sub>2</sub>	MW 174.67		
			25 g	27.00 €				25 g	42.00 €		
			50 g	36.00 €				50 g	55.00 €		
			100 g	55.00 €				100 g	75.00 €		
			250 g	122.00 €				250 g	135.00 €		
			500 g	219.00 €				500 g	189.00 €		
			1 kg	395.00 €				1 kg	265.00 €		
			5 kg	1'580.00 €				5 kg	1'015.00 €		

## Potential of Nanoparticle-Enhanced Ionic Liquids (NEILs) as Advanced Heat-Transfer Fluids (BI)

N. J. Bridges, A. E. Visser, E. B. Fox, *Energy Fuels* **2011**, *25*, 4862-4864

In recent years ionic liquids have been widely studied as heat transfer fluids (HTFs). The lack of vapor pressure, their wide liquid range, higher heat capacities, higher volumetric densities and higher volumetric heat capacities are favorable properties over conventional HTFs and make ionic liquids interesting alternatives to these materials. Also nanofluids have been widely investigated as thermal conductive materials.



In the present publication *Fox et al.* describe a combination of these two technologies the so called nanoparticle-enhanced ionic liquids (NEILs) for the first time. They have shown that the dispersion of nano Al<sub>2</sub>O<sub>3</sub> or carbon black (CB) in the ionic liquid 1-butyl-2,3-dimethylimidazolium bis(trifluoromethylsulfonyl)imide (BDiMIM BTA) increases the heat capacity of the IL without affecting the thermal stability of the IL.

A 30% increase in heat capacity compared to the pure IL was observed for the tested Al<sub>2</sub>O<sub>3</sub> NEILs. In combination with the increased density of the NEILs an increase in the volumetric heat capacities between 40-70% was observed.

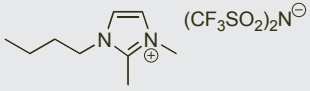

## Ionic Liquids Today, 03-11

Wednesday, November 23<sup>rd</sup>, 2011

1-Butyl-2,3-dimethylimidazolium bis(trifluoromethylsulfonyl)imide, 99% <span style="float: right;">Reduced</span>				$\gamma$ -Aluminium oxide powder, 99.9%			
IL-0104-HP	[350493-08-2]	C <sub>11</sub> H <sub>17</sub> F <sub>6</sub> N <sub>3</sub> O <sub>4</sub> S <sub>2</sub>	MW 433.39	NO-0005-HP	[1344-28-1]	Al <sub>2</sub> O <sub>3</sub>	MW 101.96
				25 g	71.00 €	25 g	25.00 €
				50 g	95.00 €	100 g	45.00 €
				100 g	160.00 €	500 g	149.00 €
				250 g	345.00 €	1 kg	249.00 €
				500 g	585.00 €		
				1 kg	995.00 €		
5 kg	3'980.00 €	H 315, 319, 335					
				P 261, 280, 302+352, 305+351+338			
				Packaging: Powder in PE bottle			

### Ionic Liquid-Mediated Selective Conversion of CO<sub>2</sub> to CO at Low Overpotentials (TB)

B.A. Rosen, A. Salehi-Khojin, M. R. Thorson, W. Zhu, D. T. Whipple, P. J. A. Kenis, R. I. Masel, *Scienceexpress* **2011**, 1-3.

For many years the electrochemical conversion of CO<sub>2</sub> was regarded as very energy inefficient since high overpotentials are required to transfer an electron onto CO<sub>2</sub> to form a species "CO<sub>2</sub><sup>-</sup>" which would be the first step of "activation". Masel *et al.* recently reported the use of ionic liquids as co-catalysts for the conversion of CO<sub>2</sub> to CO.

Their idea was that the overpotentials for CO<sub>2</sub> conversion should decrease if the free energy for the formation of the "CO<sub>2</sub><sup>-</sup>" species is lowered, which could be achieved by complexation of this species on e.g. a metal surface. Even though there would still be an activation barrier the overall energy of this barrier would be reduced.

For their initial tests they chose EMIM BF<sub>4</sub> and BMIM BF<sub>4</sub> since it is well known that imidazolium cations as well as BF<sub>4</sub> anions can form complexes with CO<sub>2</sub>. The test cell was constructed of a Pt anode and an Ag cathode separated by a Nafion membrane in order to isolate the anode from the ionic liquid. During the experiments CO<sub>2</sub> was flowing into the cell and the gaseous stream was analyzed by gas chromatography. The cathode compartment of the cell contained 18 mol% EMIM BF<sub>4</sub> in water, whereas the anode compartment contained 100 mM aqueous sulfuric acid.

Initial experiments showed the formation of CO at an applied voltage of 1.5 V (2.1 V without ionic liquid but 500mM KCl electrolyte). These results indicate that CO

## Ionic Liquids Today, 03-11

Wednesday, November 23<sup>rd</sup>, 2011

formation was achieved with an overpotential of only 0.17 V (Equilibrium potential for  $\text{CO}_2 \rightarrow \text{CO} + 1/2 \text{O}_2$  is 1.33V).

The Faradaic efficiency of the process was determined to be 96% with an energy efficiency of 87% voltages of 1.5V.

The only drawback of this process so far is the low turnover rate of less than 1 per second compared to turnover rates of 1-10 per second required for commercial electrochemical processes.

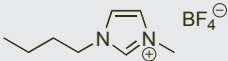
1-Butyl-3-methylimidazolium tetrafluoroborate, 99%				1-Ethyl-3-methylimidazolium tetrafluoroborate, >98%			
IL-0012-HP	[174501-65-6]	$\text{C}_8\text{H}_{15}\text{BF}_4\text{N}_2$	MW 226.02	IL-0006-HP	[143314-16-3]	$\text{C}_6\text{H}_{11}\text{BF}_4\text{N}_2$	MW 197.97
	25 g	27.00 €			25 g	65.00 €	
	50 g	36.00 €			50 g	86.00 €	
	100 g	55.00 €			100 g	130.00 €	
	250 g	122.00 €			250 g	295.00 €	
	500 g	219.00 €			500 g	525.00 €	
	1 kg	395.00 €			1 kg	945.00 €	
5 kg	1'580.00 €		5 kg	3'780.00 €			

### Solid polymer electrolytes with sulfur based ionic liquid for lithium batteries (SS)

Aaron S. Fisher, Mian B. Khalid, Matthew Widstrom, Peter Kofinas *Journal of Power Sources*, **2011**, 196, 9767– 9773.

Lithium batteries are in the focus of scientist worldwide as storage media for electric energy. The real brake through in this technology is still not achieved and a lot of research is done and will be done in the future. More and more battery scientists are investigating the use of solid polymer electrolytes in combination with ionic liquids instead of using common liquid electrolytes in the battery. One major drawback of these systems is the low conductivity of the electrolyte at low temperatures. That this drawback could be eliminated is demonstrated by Kofinas *et al.* in their recently published article. They described the electrochemical properties of a solid hybrid polymer electrolyte for lithium batteries based upon triethyl-sulfonium

## Ionic Liquids Today, 03-11

Wednesday, November 23<sup>rd</sup>, 2011

bis(trifluoromethylsulfonyl) imide (S<sub>222</sub> BTA), LiBTA, and poly(ethylene oxide) (PEO). They showed the preparation of homogenous freestanding films that possess low temperature ionic conductivity and wide electrochemical stability. The prepared hybrid electrolyte had shown an ionic conductivity of 0.117 mS/cm at 0 °C, and 1.20 mS/cm at 25 °C. Slightly increased temperature resulted in ionic conductivities on the order of 10 mS/cm. In addition their electrolyte has demonstrated reversible stability against metallic lithium at the anodic interface and >4.5 V vs. Li/Li<sup>+</sup> at the cathodic interface.

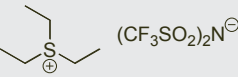
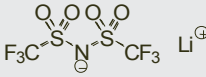
Triethylsulfonium bis(trifluoromethylsulfonyl)imide, 99%				Lithium bis(trifluoromethylsulfonyl)imide, 99%			
IL-0030-HP	[321746-49-0]	C <sub>8</sub> H <sub>15</sub> F <sub>6</sub> NO <sub>4</sub> S <sub>3</sub>	MW 399.39	KI-0001-HP	[90076-65-6]	C <sub>2</sub> F <sub>6</sub> LiNO <sub>4</sub> S <sub>2</sub>	MW 287.19
	25 g	141.00 €			100 g	110.00 €	
	50 g	189.00 €			250 g	200.00 €	
	100 g	260.00 €			500 g	275.00 €	
	250 g	585.00 €			1 kg	375.00 €	
	500 g	1056.00 €			5 kg	1500.00 €	
	1 kg	1900.00 €			10 kg	on request	
5 kg	on request						

### Paramagnetic ionic liquids as “liquid fixed-bed” catalysts in flow application (MS)

V. Misuk, D. Breuch, H. Löwe *Chem. Eng. J.* **2011**, *173*, 536– 540.

Multifunctionality of ionic liquids, ability of one compound to accommodate few different functions, is one of their more interesting characteristics that draws so much attention into research on the ionic liquids field over the last years. In their recent publication Loewe *et al.* report the use of the ionic liquid 1-butyl-3-methylimidazolium Fe<sub>2</sub>Cl<sub>7</sub> (offered as custom synthesis product from IOLITEC) as both magnetic fluid and catalyst at the same time. The ionic liquid was used the microreactor system in the reaction of esterification of Ac<sub>2</sub>O with cyclohexanol through magnetically fixed ionic liquid catalyst bed. As the reactant solution and

ionic liquid are not miscible the catalytic reaction takes place at the whole surface of the droplet while passing through the catalyst bed. The great advantage of using ionic liquids in such reaction systems is the possibility of changing the cation in the ionic liquid catalyst and thus moderating the solubility of the reactants in the ionic liquid and the ionic liquid in the substrates carrier solvent.

### **Surface loaded EMIM BTA hydrophobic ionic liquid on nano-silica sorbents for removal of lead from water samples (FS)**

Mohamed E. Mahmoud, *Desalination* **2011**, 266, 119.

Ionic Liquids (IL), often called green solvents, and IL-nanomaterial composite materials play an emerging role in science and industry applications. Purification of water and providing drinkable water is of interest due to growing world population on the one hand. On the other hand separation and capture of dissolved metal ions, especially rare metals, from water will be of interest in the future.

In contrast to liquid-liquid extraction, which can be carried out with IL, e.g. BMIM PF<sub>6</sub>, and metal-chelating additives, Mahmoud has demonstrated the separation of lead ions from water by using a composite material containing ionic liquids and nanomaterials. In this case, no task-specific modified IL was used, but EMIM BTA and nano-SiO<sub>2</sub> in order to form two new nano-silica-RTIL sorbents, which are active without chelating additives. Therefore, the nano-SiO<sub>2</sub> was activated by acid treatment and EMIM BTA was physically adsorbed. The second absorber was created by amino-modified SiO<sub>2</sub> and EMIM BTA. Both remain stable up to 300°C without degradation. The optimum pH-value was determined as 6, pH-value dependency is not strong, but the unmodified SiO<sub>2</sub>-IL-composite can take up more lead ions (~1mmol/g) compared to the modified version under the same conditions. Furthermore, after 20-30 min "reaction time" 100% of the possible extraction was completed. The uptake of lead follows the Freundlich adsorption isotherm and is only slightly interfered by various cations and anions.

## Ionic Liquids Today, 03-11

Wednesday, November 23<sup>rd</sup>, 2011

In summary, these two solid phase sorbents are very effective and easily to produce by commercially available compounds.

Silicon oxide, 99+%			
NO-0040-HP	[7631-86-9]	SiO <sub>2</sub>	MW 60.08
APS: 10-20 nm		25 g	25.00 €
SSA: 600 m <sup>2</sup> /g		100 g	45.00 €
PM: -		500 g	149.00 €
Appearance: white powder		1 kg	199.00 €
	Warning H 319, 335 P 261, 280, 305+351+338		
Packaging: Powder in PE bottle			

1-Ethyl-3-methylimidazolium bis(trifluoromethylsulfonyl)imide, 99.5% <b>NEW</b>			
IL-0023-UP	[174899-82-2]	C <sub>8</sub> H <sub>11</sub> F <sub>6</sub> N <sub>3</sub> O <sub>4</sub> S <sub>2</sub>	MW 391.31
		25 g	75.00 €
		50 g	100.00 €
		100 g	170.00 €
		250 g	365.00 €
		500 g	615.00 €
		1 kg	1045.00 €
		5 kg	on request
			

Silicon oxide + amino group, (6:1), 99.8%			
NO-0056-HP	[7631-86-9]	SiO <sub>2</sub> +NH <sub>2</sub>	
APS: 10-20 nm		10 g	25.00 €
SSA: 90-130 m <sup>2</sup> /g		25 g	55.00 €
PM: -		50 g	89.00 €
Appearance: white powder		100 g	145.00 €
		500 g	499.00 €
	Warning H 319, 335 P 261, 280, 305+351+338		
Packaging: Powder in PE bottle			

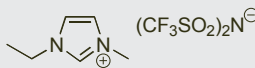
1-Ethyl-3-methylimidazolium bis(trifluoromethylsulfonyl)imide, 99%			
IL-0023-HP	[174899-82-2]	C <sub>8</sub> H <sub>11</sub> F <sub>6</sub> N <sub>3</sub> O <sub>4</sub> S <sub>2</sub>	MW 391.31
		25 g	55.00 €
		50 g	75.00 €
		100 g	120.00 €
		250 g	260.00 €
		500 g	440.00 €
		1 kg	745.00 €
		5 kg	2'980.00 €
			

### Applications of hydrophobic room temperature ionic liquids in ion-selective Optodes (FS)

Jingwei Zhu, Jingying Zhai, Xue Li, Yu Qin, *Sensors and Actuators B* **2011**, 159, 256.

Ionic Liquids due to their special properties, (liquid at room temperature, thermally stable and negligible vapor pressure) are suitable for sensor devices or other analytical applications.

Qin *et al.* demonstrated in this work an ion-selective optode with enhanced selectivity and much improved stability for hydrophilic anions. They were using a hydrophobic IL (Trihexyltetradecyl phosphonium bis(2,4,4-trimethylpentyl)phosphinate, [P<sub>666(14)</sub> phosphinate], with both hydrophobic anion and cation) as alternative plasticizer for

## Ionic Liquids Today, 03-11

Wednesday, November 23<sup>rd</sup>, 2011

PVC-IL based membranes in this device. [P<sub>666(14)</sub> phosphinate] shows excellent compatibility with PVC and forms transparent and homogeneous membranes. Different acids like HCl, H<sub>2</sub>SO<sub>4</sub> and HNO<sub>3</sub> were detected by using commercially available ETH 5294 as the pH chromoionophore. When using other membranes, the leaching of ETH 5294 with H<sub>2</sub>SO<sub>4</sub> occurs. This was eliminated by this PVC-[P<sub>666(14)</sub> phosphinate] based membrane and is the big advantage of this new IL-PVC-membrane.

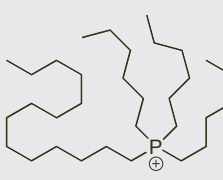
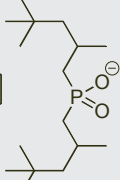
<b>Trihexyltetradecylphosphonium bis(2,4,4-trimethylpentyl)phosphinate, &gt;95%</b>			<b>Reduced</b>
IN-0009-TG	[465527-58-6]	C <sub>48</sub> H <sub>102</sub> O <sub>2</sub> P <sub>2</sub>	MW 773.27
		25 g	32.00 €
		50 g	43.00 €
		100 g	82.00 €
		250 g	193.00 €
		500 g	366.00 €
		1 kg	695.00 €
		5 kg	on request
A product of Cytec Industries Inc. (CYPHOS® IL-104)			

### Plasma electrochemistry in ionic liquids: an alternative route to generate nanoparticles (TS)

O. Höfft, F. Endres *Phys. Chem. Chem. Phys.* **2011**, *13*, 13472.

We at IOLITEC know very well that nanomaterials and ionic liquids is a fruitful symbiosis. The most common way is of course to use the surface active properties of ionic liquids for the synthesis and/or dispersion of nanomaterials. Synthetic chemical methods dominate this field, but if the negligible vapor pressure is brought into consideration, another exciting field can be opened: Plasma electrochemistry in ionic liquids.

Though the reactor setup is complex compared to normal chemistry, the chemistry to synthesize nanoparticles is really simple: The generated electrons reduce the metal salt, which is dissolved inside the ionic liquid. The reduced metal forms very small nanoparticles because the ionic liquid is avoiding larger crystallites and prevents the nanoparticles from agglomeration.

## Ionic Liquids Today, 03-11

Wednesday, November 23<sup>rd</sup>, 2011

In this context, there are no ionic liquids of choice, because for each metal salt a suitable ionic liquid has to be found. On the other hand, high conductivity and low viscosity (for a good mass transport) as well as electrochemical stability are properties, which are beneficiary for this application. In addition, the anion should be non- or weakly coordinating, in particular if ultra small particles shall be yielded.

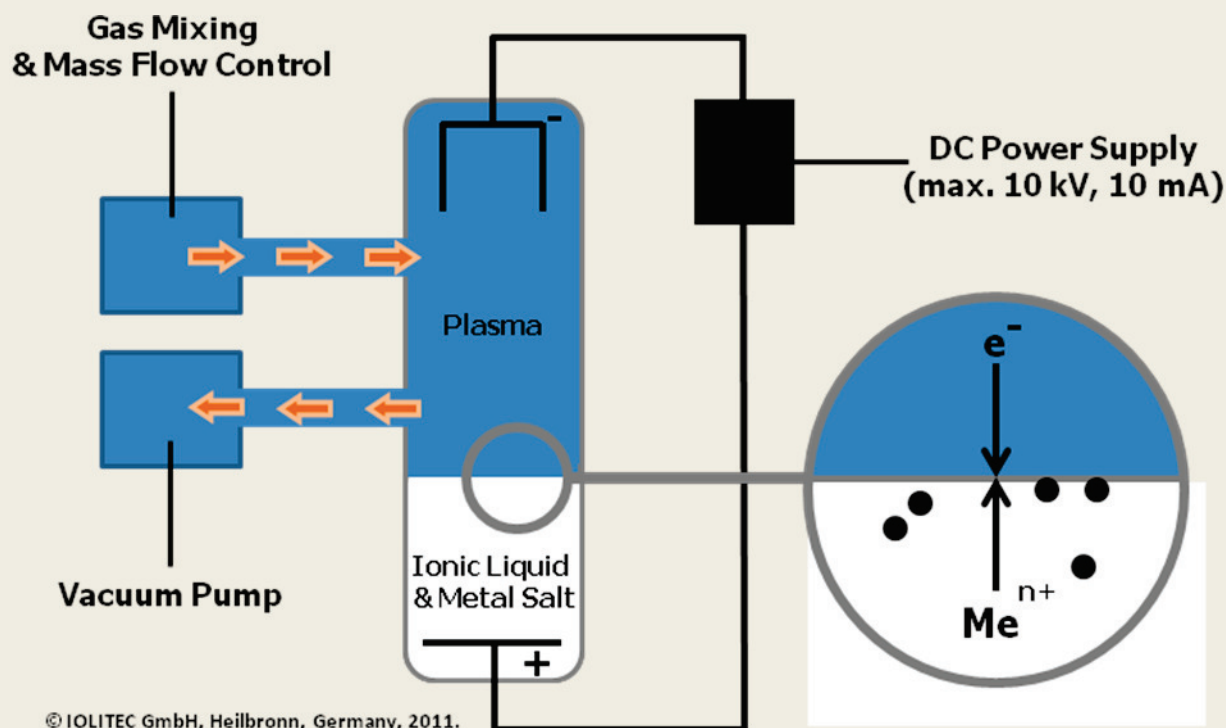

In their perspective article *Endres* and *Höfft* summarize the state of the art of plasma electrochemistry in ionic liquids. Enjoy!

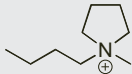
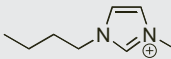
1-Butyl-1-methylpyrrolidinium bis(trifluoromethylsulfonyl)imide, 99%				1-Butyl-3-methylimidazolium trifluoromethanesulfonate, 99%				Reduced
IL-0035-HP	[223437-11-4]	C <sub>11</sub> H <sub>20</sub> F <sub>6</sub> N <sub>2</sub> O <sub>4</sub> S <sub>2</sub>	MW 422.41	IL-0013-HP	[174899-66-2]	C <sub>9</sub> H <sub>15</sub> F <sub>3</sub> N <sub>2</sub> O <sub>3</sub> S	MW 288.29	
 $(\text{CF}_3\text{SO}_2)_2\text{N}^\ominus$	25 g	52.00 €		 $\text{CF}_3\text{SO}_3^\ominus$	25 g	61.00 €		
	50 g	69.00 €			50 g	82.00 €		
	100 g	115.00 €			100 g	123.00 €		
	250 g	235.00 €			250 g	275.00 €		
	500 g	385.00 €			500 g	497.00 €		
	1 kg	695.00 €			1 kg	895.00 €		
5 kg	2780.00 €		5 kg	3580.00 €				

## Ionic Liquids Today, 03-11

Wednesday, November 23<sup>rd</sup>, 2011

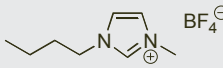
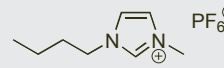
1-Butyl-3-methylimidazolium tetrafluoroborate, 99%				1-Butyl-3-methylimidazolium hexafluorophosphate, 99% <b>Reduced</b>			
IL-0012-HP	[174501-65-6]	C <sub>8</sub> H <sub>15</sub> BF <sub>4</sub> N <sub>2</sub>	MW 226.02	IL-0011-HP	[174501-64-5]	C <sub>8</sub> H <sub>15</sub> F <sub>6</sub> N <sub>2</sub> P	MW 284.18
		25 g	27.00 €			25 g	31.00 €
		50 g	36.00 €			50 g	41.00 €
		100 g	55.00 €			100 g	62.00 €
		250 g	122.00 €			250 g	139.00 €
		500 g	219.00 €			500 g	250.00 €
		1 kg	395.00 €			1 kg	450.00 €
5 kg	1'580.00 €	5 kg	1'800.00 €				

### On the formation of anisotropic gold nanoparticles by sputtering onto a nitrile functionalised ionic liquid (TS)

H. Wender, P. Migowski, A. F. Feil, L. F. de Oliveira, M. H. G. Pechtl, R. Leal, G. Machado, S. R. Teixeira, J. Dupont *Phys. Chem. Chem. Phys.* **2011**, *13*, 13552.

Sputtering metal nanoparticles on ionic liquids and plasma electrochemistry in ionic liquids are both potential methods for the production of metal nanoparticles. Both have in common that they are vacuum techniques, but the main difference between them is that the metal in sputtering techniques is first brought into the gas phase and is then reduced at the gas-liquid interface, while in plasma electrochemistry the electron comes out of the gas (or more precise plasma) phase and reduces the dissolved metal also at the plasma-liquid interface.

Dupont and coworkers described in their interesting article the role of the nitrile group in nitrile functionalized ionic liquids at the interface between gas and liquid phase. They mentioned that just by controlling the physical parameters of the sputtering process, it was possible to control size, size-distribution, and shape of gold nanoparticles.



### 7 New Products

By Thomas J. S. Schubert.

Driven by our customers' needs, we try to develop and extend our product range continuously. In this context, the most often asked questions are:

- Are products with lower viscosities and higher conductivities available?
- Are high-purities above 99% as colorless liquids available?
- Are smaller research quantities for screening-tests available?

As you can surely imagine, our answer is "yes!"

#### **Low viscous ionic liquids based on the Tricyanomethide-anion**

The physical-chemical properties of ionic liquids are influenced mostly by the anion, while the cation is responsible for fine-tuning or tailoring. Next to solvents, the use of ionic liquids as electrolytes is surely one of the most important applications and, as a consequence, the viscosity and conductivity are the most important properties.

When the dicyanamide- (DCA)-anion entered the ionic liquids world, the conductivity scratched 20 mS/cm, a value which in combination with the 1-ethyl-3-methylimidazolium-cation at that time only was achieved by highly corrosive ionic liquids and by ionic liquids based on the thiocyanate-anion. Just a few years later, *Gores* introduced tetracyanoborate-based ionic liquids, which are even lower viscous and higher conductive, and thus are interesting materials.

In this context, the missing piece is the carbon-homologue, since in the periodic system carbon is located between boron and nitrogen. The tricyanomethide-anion (or methanide) is in principle very attractive, since the charge is delocalized in an optimum way, leading to a really weakly coordinating species, resulting in viscosities of 12.2 cP at 30°C and a conductivity of 17 mS/cm for 1-ethyl-3-methylimidazolium tricyanomethanide (IL-0316-HP).

**Please ask also for other types of cation combined with this anion!**

## Ionic Liquids Today, 03-11

Wednesday, November 23<sup>rd</sup>, 2011

### 1-Ethyl-3-methylimidazolium tricyanomethanide, >98%

**NEW**

IL-0316-HP    [--]    C<sub>10</sub>H<sub>11</sub>N<sub>5</sub>    MW 201.23

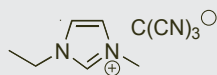

25 g	91.00 €
50 g	122.00 €
100 g	162.00 €
250 g	344.00 €
500 g	585.00 €
1 kg	998.00 €
5 kg	on request

### Colorless Ionic Liquids with purities above 99.5%

Over the past years we were frequently asked for higher purities, and in particular for *colorless ionic liquids*. Even though only traces below 1 ppm can cause a slightly yellowish color, these traces may have a strong impact on those applications, where interfaces play an important role. This is in particular true for electrochemical applications, where traces of impurities can strongly influence the electrode surfaces, leading to misleading results. Another aspect are optical applications, where crystal clear fluids are required. If you are interested, please contact us, other ultrapure & colorless ionic liquids will follow, soon!

### 1-Ethyl-3-methylimidazolium bis(trifluoromethylsulfonyl)imide, 99.5%

**NEW**

IL-0023-UP    [174899-82-2]    C<sub>8</sub>H<sub>11</sub>F<sub>6</sub>N<sub>3</sub>O<sub>4</sub>S<sub>2</sub>    MW 391.31

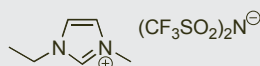

25 g	75.00 €
50 g	100.00 €
100 g	170.00 €
250 g	365.00 €
500 g	615.00 €
1 kg	1045.00 €
5 kg	on request

### 1-Methyl-3-propylimidazolium bis(trifluoromethylsulfonyl)imide, 99.5%

**NEW**

IL-0024-UP    [216299-72-8]    C<sub>9</sub>H<sub>13</sub>F<sub>6</sub>N<sub>3</sub>O<sub>4</sub>S<sub>2</sub>    MW 405.34

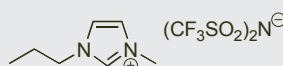

25 g	95.00 €
50 g	130.00 €
100 g	215.00 €
250 g	460.00 €
500 g	780.00 €
1 kg	1325.00 €
5 kg	on request

### 1-Methyl-1-propylpyrrolidinium bis(trifluoromethylsulfonyl)imide, 99.5%

**NEW**

IL-0044-UP    [223437-05-6]    C<sub>10</sub>H<sub>18</sub>F<sub>6</sub>N<sub>2</sub>O<sub>4</sub>S<sub>2</sub>    MW 408.38

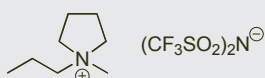

25 g	72.00 €
50 g	100.00 €
100 g	160.00 €
250 g	330.00 €
500 g	545.00 €
1 kg	975.00 €
5 kg	on request

### 1-Butyl-1-methylpyrrolidinium bis(trifluoromethylsulfonyl)imide, 99.5%

**NEW**

IL-0035-UP    [223437-11-4]    C<sub>11</sub>H<sub>20</sub>F<sub>6</sub>N<sub>2</sub>O<sub>4</sub>S<sub>2</sub>    MW 422.41

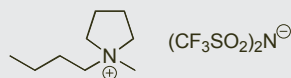

25 g	72.00 €
50 g	100.00 €
100 g	160.00 €
250 g	330.00 €
500 g	545.00 €
1 kg	975.00 €
5 kg	on request

## Ionic Liquids for Screening-Tests: MyKit



The introduction of our novel ionic-liquids-screening-kits is a consequence of many fruitful discussions with our customers. First of all, we switched from 25 g to 10 g, which is surely enough for the most screening purposes. Secondly, we selected 58 common ionic liquids, which are now available at **unified prices**, independently from the particular ionic liquid, but depending on the number of items:

- 5 to 9 items: 40 €/per ionic liquid
- 10 to 24 items: 35 €/per ionic liquid
- 25 to 50 items: 30 €/per ionic liquid

MyKit starts in general with 5 and is limited to maximum 50 items. Within the 59 different ionic liquids it is possible to combine any kind and/or number of items.

1-Ethyl-3-methylimidazolium tetrafluoroborate (IL-0006-HP)	Triethylsulfonium bis(trifluoromethylsulfonyl)imide (IL-0030-HP)	1-Hexyl-3-methylimidazolium triflate (IL-0070-HP)
1-Butyl-3-methylimidazolium tetrafluoroborate (IL-0012-HP)	Methyltrioctylammonium bis(trifluoromethylsulfonyl)imide (IL-0017-HP)	1-Methyl-3-octylimidazolium triflate (IL-0073-HP)
1-Hexyl-3-methylimidazolium tetrafluoroborate (IL-0019-HP)	1-Ethyl-3-methylimidazolium bis(trifluoromethylsulfonyl)imide (IL-0023-HP)	1-Butyl-1-methylpyrrolidinium triflate (IL-0113-HP)
1-Methyl-3-octylimidazolium tetrafluoroborate (IL-0021-HP)	1-Methyl-3-propylimidazolium bis(trifluoromethylsulfonyl)imide (IL-0024-HP)	1-Ethyl-3-methylimidazolium thiocyanate (IL-0007-HP)
1-Butylpyridinium tetrafluoroborate (IL-0089-HP)	1,2-Dimethyl-3-propylimidazolium bis(trifluoromethylsulfonyl)imide (IL-0134-HP)	1-Ethyl-3-methylimidazolium dicyanamide (IL-0003-HP)
1-Butyl-3-methylpyridinium tetrafluoroborate (IL-0081-HP)	1-Butyl-3-methylimidazolium bis(trifluoromethylsulfonyl)imide (IL-0029-HP)	1-Butyl-3-methylimidazolium dicyanamide (IL-0010-HP)
1-Butyl-4-methylpyridinium tetrafluoroborate (IL-0085-HP)	1-Butyl-2,3-dimethylimidazolium bis(trifluoromethylsulfonyl)imide (IL-0104-HP)	1-Butyl-1-methylpyrrolidinium dicyanamide (IL-0041-HP)
1-Butyl-3-methylimidazolium hexafluorophosphate (IL-0011-HP)	1-Hexyl-3-methylimidazolium bis(trifluoromethylsulfonyl)imide (IL-0098-HP)	1-Ethyl-3-methylimidazolium chloride (IL-0093-HP)
1-Hexyl-3-methylimidazolium hexafluorophosphate (IL-0018-HP)	1-Hexadecyl-3-methylimidazolium bis(trifluoromethylsulfonyl)imide (IL-0103-HP)	1-Butyl-3-methylimidazolium chloride (IL-0014-HP)
1-Methyl-3-octylimidazolium hexafluorophosphate (IL-0020-HP)	1-Allyl-3-methylimidazolium bis(trifluoromethylsulfonyl)imide (IL-0239-HP)	1-Allyl-3-methylimidazolium chloride (IL-0022-HP)
1-Butylpyridinium hexafluorophosphate (IL-0088-HP)	1-Methyl-1-propylpyrrolidinium bis(trifluoromethylsulfonyl)imide (IL-0044-HP)	Trihexyltetradecylphosphonium chloride (IN-0006-TG)
1-Butyl-3-methylpyridinium hexafluorophosphate (IL-0080-HP)	1-Butyl-1-methylpyrrolidinium bis(trifluoromethylsulfonyl)imide (IL-0035-HP)	1-Ethyl-3-methylimidazolium bromide (IL-0015-HP)
1-Butyl-4-methylpyridinium hexafluorophosphate (IL-0084-HP)	1-Methyl-1-propylpiperidinium bis(trifluoromethylsulfonyl)imide (IL-0045-HP)	1-Butyl-3-methylimidazolium bromide (IL-0037-HP)
1-Ethyl-3-methylimidazolium diethylphosphate (IL-0052-HP)	1-Butylpyridinium bis(trifluoromethylsulfonyl)imide (IL-0213-HP)	1,3-Dimethylimidazolium iodide (IL-0199-HP)
1,3-Dimethylimidazolium dimethylphosphate (IL-0053-HP)	1-Butyl-3-methylpyridinium bis(trifluoromethylsulfonyl)imide (IL-0216-HP)	1-Ethyl-3-methylimidazolium iodide (IL-0048-HP)
Choline dihydrogenphosphate (IL-0042-HP)	1-Butyl-4-methylpyridinium bis(trifluoromethylsulfonyl)imide (IL-0219-HP)	1-Methyl-3-propylimidazolium iodide (IL-0025-HP)
1-Ethyl-3-methylimidazolium ethylsulfate (IL-0033-HP)	Trihexyltetradecylphosphonium bis(trifluoromethylsulfonyl)imide (IN-0021-HP)	1-Butyl-3-methylimidazolium iodide (IL-0051-HP)
1-Ethyl-3-methylimidazolium hydrogensulfate (IL-0091-HP)	1-Ethyl-3-methylimidazolium triflate (IL-0009-HP)	1-Hexyl-3-methylimidazolium iodide (IL-0026-HP)
1-Ethyl-3-methylimidazolium acetate (IL-0189-TG)	1-Butyl-3-methylimidazolium triflate (IL-0013-HP)	1-Allyl-3-methylimidazolium iodide (IL-0231-HP)
Ethylammonium nitrate (IL-0043-SG)		

### 8 Community

#### IOLITEC@ Social Media



Please follow IOLITEC at Facebook or connect yourself with IOLITEC's team at LinkedIn!

We invite you to become a member of the **Ionic Liquids group** on Facebook. Researchers, students, professionals from industry are welcome! From time to time we'll inform about latest publications on Facebook or we are open for any type of discussions!



#### Ionic Liquids @ Youtube:

##### **Ionic Liquid based humidity sensor:**

<http://www.youtube.com/watch?v=kkXIUcFO6Zc>

##### **Extraction:**

By Penn State University:

<http://www.youtube.com/watch?v=sGDKxIW1ZoQ&feature=related>

Please inform us about other ionic liquids or nanomaterial-related links. Other links can be seen at our web-pages ([www.iolitec.com](http://www.iolitec.com)).

## **Ionic Liquids Today, 03-11**

Wednesday, November 23<sup>rd</sup>, 2011

---

### **Upcoming Exhibitions and Conferences:**

**November 27<sup>th</sup> – December 1<sup>st</sup>, 2011: International Symposium on Molten Salts and Ionic Liquids, Cancun, Mexico ([www.flogen.com](http://www.flogen.com) )**

**IL Mat 2011 - Ionic Liquids Derived Materials, Vienna, Austria, December 5-6, 2011**

<http://www.imc.tuwien.ac.at/ilmat/index.htm>

This two days symposium will bring together various people active in this field of IL derived materials. IOLITEC will give a presentation entitled “**Ionic Liquids as Novel Media for Sustainable Energy Applications - an Overview**”.

**18th International Colloquium Tribology Industrial and Automotive Lubrication, Stuttgart/Ostfildern, Germany, January 10-12, 2012**

<http://www.tae.de/de/kolloquien-symposien/18th-international-colloquium-tribology.html>

In January 2012 the 18th Colloquium on Tribology will be held in Ostfildern/Stuttgart. IOLITEC will give a presentation entitled “**Ionic Liquids and Ionic Liquid-Mediated Dispersions of Nanomaterials as High Performance Additives for Lubricants**”.

**ACS National Meeting Spring 2012, San Diego/CA, USA, March 25-29, 2012**

<http://www.acs.org>

During the ACS Spring Meeting 2012 in San Diego two sessions will be held on Ionic Liquids.

The first session organized by Rani Jha has the title “**Green Solvents & Ionic Liquids as the Next Generation of Green Solvents**”. The second session which is organized by Ann Visser (SRNL), Nick Bridges (SRNL) and Robin Rogers (The University of Alabama) is entitled “**Ionic Liquids: Science & Application**” Both sessions are part of the program of the Industrial and Engineering Chemistry Division.

In addition, a symposium in Honor of Robin Rogers who will become an Industrial & Engineering Chemistry Fellow will be held.

## **Ionic Liquids Today, 03-11**

Wednesday, November 23<sup>rd</sup>, 2011

---

### **ACHEMA 2012 Congress, Frankfurt, Germany, June 18-22, 2012**

[http://kongress.achema.de/achema\\_kongress/en/congress.html](http://kongress.achema.de/achema_kongress/en/congress.html)

In June 2012 the ACHEMA will be held in Frankfurt again. IOLITEC will give two presentations entitled "**Ionic liquids as novel dispersing agents for nanoparticles: Easy- and safe-to-handle dispersions for energy applications**" and "**Ionic liquids as thermal fluids revisited**" on accompanying the congress.

### **Smart Coatings 2012, Orlando/FL, USA, February 22-24, 2012**

<http://www.Smartcoatings.org>

In February 2012 the Smart Coatings conference will be held in Orlando Florida. IOLITEC will give a presentation entitled "**Ionic Liquids – Suitable Materials for Coating Technologies**".

### **EUCHEM 2012, Celtic Manor, Wales, August 5<sup>th</sup>-19<sup>th</sup>, 2012.**

<http://www.euchem2012.org>

The EUCHEM 2012 takes place at Celtic Manor, a really nice location. The EUCHEM-series brings together two separated twins: Molten salts and ionic liquids.

**Please keep us informed about other interesting events we could highlight in Ionic Liquids Today.**

## **Ionic Liquids Today, 03-11**

Wednesday, November 23<sup>rd</sup>, 2011

---

### **Imprint**

© 2011, Ionic Liquids Technologies GmbH, Heilbronn, Germany.

### **Contact and Order Information:**

---



#### **World**

**Asia, Australia, South America,  
Middle East & Europe (non EU)**

**Dr. Sven Sauer**

[sauer@iolitec.de](mailto:sauer@iolitec.de)



#### **EU**

**European Union (except Austria,  
Germany & Switzerland)**

**Dr. Boyan Iliev**

[iliev@iolitec.de](mailto:iliev@iolitec.de)



#### **D A CH**

**Switzerland, Austria & Germany**

**Dr. Maria Taige**

[taige@iolitec.de](mailto:taige@iolitec.de)

#### **World, EU & DACH:**

Payment by wire-transfer or cheque.

**EU:** Please add your VAT-ID-number to all orders.

#### **IOLITEC**

**Ionic Liquids Technologies GmbH**

Global Headquarters

Salzstraße 184

D-74076 Heilbronn, Germany

phone: +49 (0) 7131 89839 0

fax: +49 (0) 7131 89839 109

[info@iolitec.de](mailto:info@iolitec.de)

[www.iolitec.com](http://www.iolitec.com)



#### **NAFTA**

**USA, Canada & Mexico**

**Dr. Tom Beyersdorff**

[beyersdorff@iolitec.com](mailto:beyersdorff@iolitec.com)

Payment by Credit Card, Cheque  
Wire Transfer is possible.

#### **IOLITEC**

**Ionic Liquids Technologies Inc.**

720 2<sup>nd</sup> Street, AIME

Tuscaloosa, AL 35401, USA

phone: +1 (205) 348 2831

fax: +1 (205) 348 3510

[info@iolitec-usa.com](mailto:info@iolitec-usa.com)

[www.iolitec-usa.com](http://www.iolitec-usa.com)